

Artize

TIAARA OXY
SUPERIOR

OWNER'S MANUAL

Safety, Operation, Maintenance, and Warranty

SAFETY GUIDELINES

This manual contains information for YOUR SAFETY and will also help in PREVENTING PROBLEMS. To help you recognise these items of importance, this document uses the following symbols. PLEASE read the manual and pay special attention to these sections.

SAVE THESE INSTRUCTIONS!

DANGER !

Urgent Safety Information
A Hazard That Will Cause Serious Injury

WARNING

Important Safety Information
A Hazard That Might Cause Serious Injury

CAUTION

Information To Prevent
Damage To Equipment



Important Instructions and
References

Model:

Serial/ Invoice No.:

Owner's Record

Date of Installation:

Name of Installer:

Telephone:

This information may be required for service and warranty.



IMPORTANT SAFETY INSTRUCTIONS

Basic precautions to be taken to prevent fire hazards, electrical shocks, personal injury or damage when using your unit. **READ AND FOLLOW ALL INSTRUCTIONS!**

DANGER !

READ AND FOLLOW ALL INSTRUCTIONS

- Risk of lethal electric shock in Hydroelectric product. To reduce risk of electric shock, connect your product only to circuits protected by a Ground-Fault Circuit-Interrupter (GFCI) or Residual Current Device (RCD)-sensitivity not more than 30 Milliamp (mA)
- CIRCUIT INTERRUPTER (GFCI). A GFCI should be provided by the entrepreneur electrician and should be routinely tested. To test the GFCI, push the test button. The GFCI should interrupt power. Push the reset button. Power should be restored. If the GFCI fails to operate in this manner, there is a ground fault, indicating the possibility of electrical shock. **DO NOT USE THE UNIT.** Disconnect the unit and have the problem corrected by a qualified electrician before using
- Never operate electrically connected devices in or near the bath. Never drop or insert any object into any opening. Do not use electrical appliances while in the tub
- To reduce the risk of injury, do not allow children to use this unit unless they are closely supervised at all times. Those requiring supervision should never be allowed to use the units unattended
- Use the unit only for its intended use as described in this manual. Do not use attachments not recommended by the manufacturer
- Never drop any objects into any openings/holes within the product.
- Do not use the oxypool if the protective cover is not installed on the suction intake. Keep foreign objects, including hair, away from the suction intake as they could block the intake or get caught in it. For comfort and safety, persons with long hair should tie their hair in a bun to keep it out of the water and away from the suction fitting. Keep your head above water at all times

WARNING**IMPORTANT SAFETY INFORMATION**

- Persons under a doctor's care, pregnant women, persons with high or low blood pressure, heart disease, diabetes, or any serious illness, should not use this unit without prior consultation with their physician. Never use this unit while under the influence of any drug or alcohol.
- The maximum temperature of the water should never exceed 104°F (40°C).

CAUTION**INFORMATION TO PREVENT DAMAGE TO EQUIPMENT**

- To reduce risk of injury, enter and exit the bath carefully.
- Do not fill the tub beyond the air volume controls or the overflow.
- Never operate the oxypool system if there is less than 2" (5 cm) of water over the highest whirlpool jet (except for the back jets) or if the bathtub is empty.
- Do not bathe pets in your whirlpool. Their hair could clog the pump.
- Make sure the water temperature does not exceed 104°F (40°C). Damage and discoloration of the acrylic surface may occur.
- The oxypool should be drained after each use.
- Oil-based additives must not be used, and cleaning instructions must be followed. Do not use harsh abrasives or solvents for cleaning your oxypool.

• SAVE THESE INSTRUCTIONS •



Dear Product Owner,

Thank you for choosing an Artize product. The minute you sit back and relax in your new product you'll see and feel the difference. In your whirlpool, jets are strategically placed to create a soothing, swirling flow of relaxing water. It's the OXYPOOL action which you'll only experience in Artize products..

Now relax and enjoy your bath in your new ARTIZE OXYPOOL.

Sincerely,
Artize.

CONTENT

Oxypool Specifications-----	07	Operating The Controls-----	18
Oxypool and Bathtub Sizes-----	08	Electronic Control	
Installation Legend Diagram-----	9	How To Use Your Oxypool-----	19
Pre-installation Requirements-----	10	User Maintenance Instructions-----	20
Tools For Installation		Cleaning The Tub Surface	
Before You Start		Cleaning the Pump and Plumbing System	
Installation Procedure-----	12	Minor Scratches and Scuffs	
Electrical Supply and Safety Devices		Major Repairs To The Surface	
Components Identification		Jet Hardware Wrench	
Block Connection Diagram-----	16	Troubleshooting-----	22
ECU Terminal Connection Diagram		Oxypool System	

OXYPOOL SPECIFICATION

TECHNICAL INFO			SAFETY	
Size	1900*900x670/mm		3 Tier Testing	Yes
Depth	520mm		Steel Frame	Yes
Material	Acrylic		SANITISATION	
Reinforcement	PU		Sanitisation/ Cleaning System	No
Oxypool Jets	2		Food Grade Pipe	Yes
Pump Oxypool	1.8 HP		Level Sensor	Yes
Chromotherapy	Yes (2)		CONTROLLER	
Headrest	Yes		Digital	Yes
Overflow Cum Filler	Yes		Manual	No
Keypad	Yes		Cross	No
Power Rating (Max)	1.5KW		Smart	No
OXYPOOL (ARTIZE190X90)			WARRANTY	
S. No.	DESCRIPTION	REMARKS	Body	5 years
1	Gross Weight	68.5Kg	Electrical	2 years
2	Dry Weight	48.7Kg	Jets	5 years
3	Water Capacity (Ltr)	205Ltr		

OXYPOOL BATHTUB SIZES

Product Dimensions

A Top View

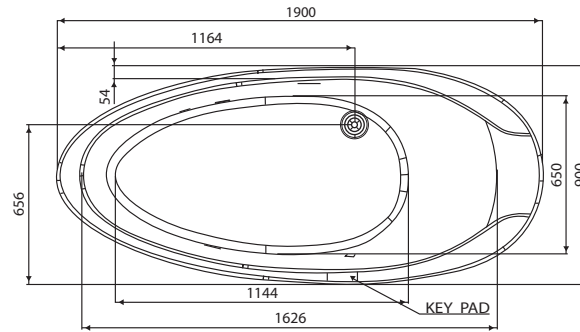

B Side View

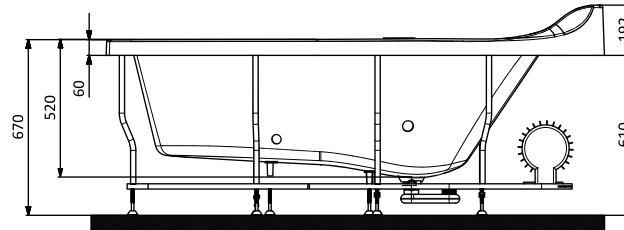

PRE-INSTALLATION REQUIREMENTS

Tools for Installation

Safe use of tools:

- Wear safety glasses or a face shield (with safety glasses or goggles) and well-fitting gloves for safety.
- Ensure that users are properly trained in the safe use of hand tools.
- Select the right tool for the job. Substitutes increase the chance of having an accident.
- Replace cracked, splintered, or broken handles on files, hammers, screwdrivers, or sledges.
- Ensure that the handles of tools like hammers and axes fit tightly into the head of the tool.
- Use and maintain tools carefully. Keep them dry and store them properly after each use.

Tools Required For Installation: (Not Included)

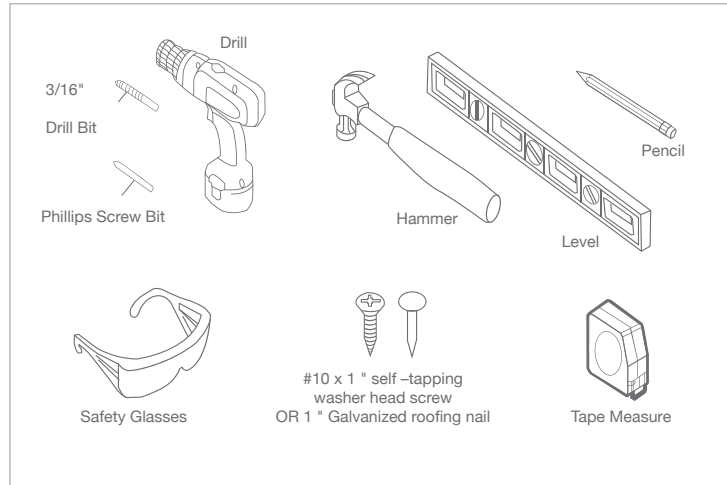

Before You Start

IMPORTANT: Observe all governing codes and ordinances.

1. Proper installation is your responsibility. Ensure a qualified/Jaquar technician installs your product.
2. An air vent and a service window must be provided for product as basic requirement.
3. Electrical supply requirement: 220~240 volt (16 A)

 Fluctuation may damage the product or its component. Manufacturer recommends the use of fluctuation free or stabilized power supply to feed the product.

4. Water supply parameters like pH/hardness must be maintained at below recommended level.

pH 7.5 – 8.5

TH 150 – 450 ppm.

Sanitizer 2- 4 ppm

Earth Wire

The earth wire must be connected and fixed permanently with a 3 mm dia. core conductor to the electrical system.

Electrical Supply and safety devices.

- a) The equipment must be connected to single phase 220 ~ 240 V and 50hz supply.
- b) The equipment must be connected to the equipotential/ differential switches of the room and duly fastened to the specified clamp/terminals that can be found on the product.
- c) Connection to the power mains foresees installation of a 30mA max. differential switch (RCCB/ELCB/GFCI), with at least 3 mm contact opening and suitable for a single phase supply.
- d) Switches must be arranged near the device, upstream of power boxes (only for product versions equipped with power box).
- e) The product's supporting structure is made of metal, therefore an efficient ground dispersal provision is required, with regulations compliant sensitivity.

INSTALLATION PROCEDURE

Place your oxypool/bathtub on flat surface & check level for water flow towards drain.



Water drain may be adjusted by leg adjustment

 Pictures used above for reference only.
For product placement check dimensions
of required model.

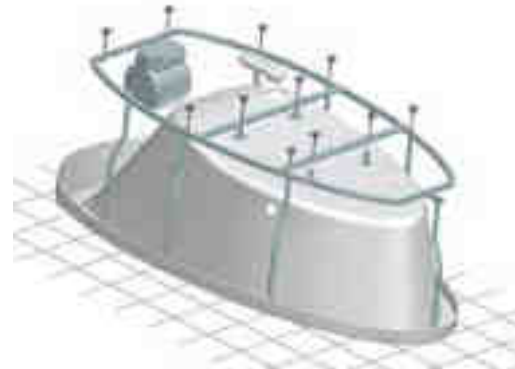

Connecting drain pipe : Use a flexible pipe of diameter 40 mm - not supplied with the product.



Note: Connecting pipe (Flexible pipe of diameter 40)

Fill a minimum 4 litres of water in the bathtub to check proper drain flow

 Pictures used above for reference only.
For product placement check dimensions
of required model.



-  It is recommended that the product be kept filled for 24 hours to check for leakages in plumbing/drain connections.

Electrical supply and safety devices

- f) The equipment must be connected to single phase 220 ~ 240 V and 50hz supply.
- g) The equipment must be connected to the equipotential/ differential switches of the room and duly fastened to the specified clamp/ terminals that can be found on the product.
- h) Connection to the power mains foresees installation of a 30mA max. differential switch (RCCB/ELCB/GFCI), with at least 3mm contact opening and suitable for a single phase supply.
- i) Switches must be arranged near the device, upstream of power boxes (only for product versions equipped with power box).
- j) The product supporting structure is made of metal, therefore an efficient ground dispersal provision is required, with regulations compliant sensitivity.¹⁵



Component Identification

- ☞ These drawings represent only the major components of the system; the position of the components may vary depending on the bath model.

These pictures represent Combined Systems; Oxypool Systems components are identified with “Component Identification”.

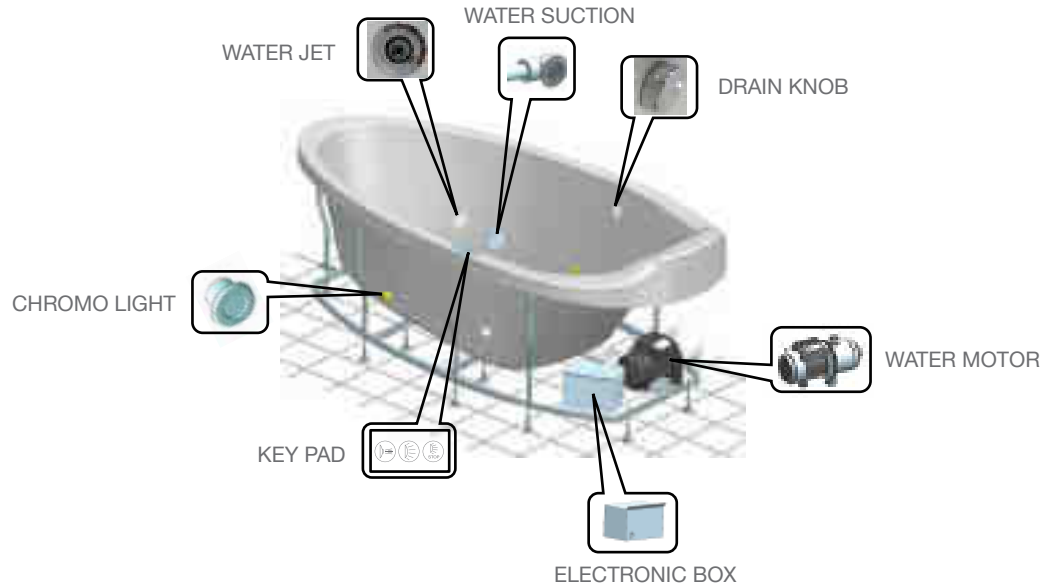

BLOCK CONNECTIONS DIAGRAM

WHIRL POOL CNTROL TYPE 240 9043C - S06

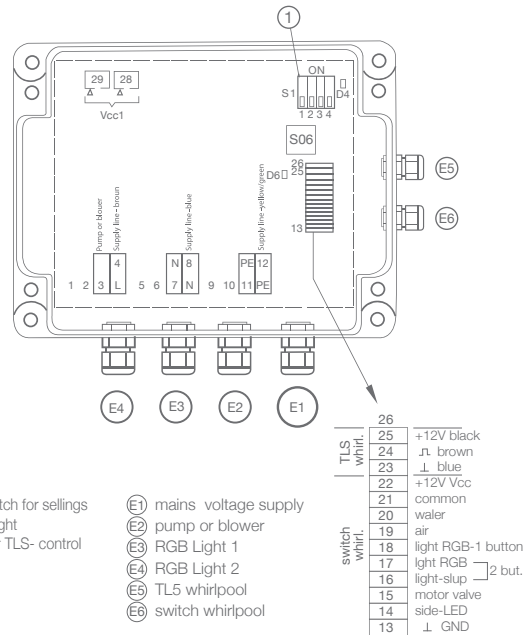

① DP-switch for sellings
28, 29 EGB Light
D6 LED for TLS-control

① mains voltage supply
② pump or blower
③ RGB Light 1
④ RGB Light 2
⑤ TL5 whirlpool
⑥ switch whirlpool

26
25 +12V black
24 r brown
23 l blue
22 +12V Vcc
21 common
20 water
19 air
18 light RGB-1 button
17 light RGB } 2 but.
16 light-slip }
15 motor valve
14 side-LED
13 l GND

DP-switch	NO	OFF
S1.1	supply voltage Vcc1 10v / 5v	
S1.2	TLS-sensor RGB light deactivated / active	
S1.3	- dry out automatic / manual	
S1.4	interval ON / OFF	

Technical Data

Nominal voltage 220-240v AC 50/60Hz
Total connected load max. 15kw (max. 6A)
Switching current each channel 6A at cos phi = 1
Power Vcc1 max. 10w
System of pretection IP55
Housing dimensions 130x95x60mm

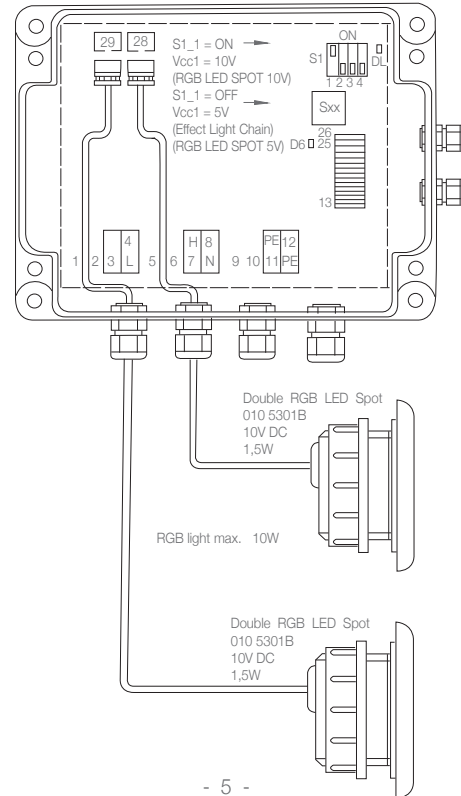

Ecu Terminal connections Diagram

Oxypool Lighting Connection

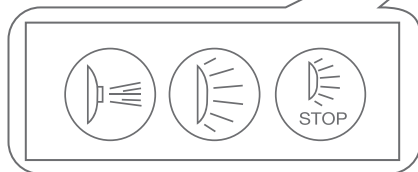

OPERATING THE CONTROLS



Position	Symbol	Fuction
1		Oxypool
2		Light On
3		Light Stop



HOW TO USE YOUR OXYPOOL

BEFORE TAKING YOUR FIRST BATH, READ AND APPLY THE "IMPORTANT SAFETY INSTRUCTIONS".

To reduce the risk of injury, do not permit children to use the oxypool unless they are closely supervised at all times. Those requiring supervision for any reason, should never be allowed to use the oxypool unattended. Persons under a doctor's care, pregnant women, persons with high blood pressure, heart disease, diabetes, or any serious illness, should not use a oxypool without prior consultation with their physician. Never use a oxypool while under the influence of any drugs or alcohol.

Do not use the oxypool if protective cover is not installed on the suction intake. Keep foreign objects, including hair, away from the suction intake as they could block the intake or get caught in it. For comfort and safety, persons with long hair should tie their hair in a bun to keep it out of the water and away from the suction fitting. Never place your head below the surface of the water.

TIME TO RELAX

It's time to relax, unwind, daydream, meditate. Lie back and relax while the effervescent oxypool action works on your body and floats away your cares.

WATER TEMPERATURE

Warm to moderately hot water is ideal for a relaxing and comfortable whirlpool bath. That temperature is between 100° F and 102° F. The maximum water temperature should never exceed 104° F. If your system uses the electronic control with back lighting, the LCD displays the temperature when the system is on. Try cooler water for an invigorating oxypool.

Temperatures exceeding 104°F may induce hyperthermia. Hyperthermia occurs when the internal temperature of the body reaches a level several degrees above normal body temperature of 98.6° F. The effects of hyperthermia include: failure to perceive heat, failure to recognise the need to exit the oxypool and unawareness of pending hazards.

FILLING THE TUB

When the tub is filled with water above the highest jet, step in and sit down before turning the whirlpool on. Do not fill over the air controls or bath waste handles. We recommend this procedure for two reasons. Some switching systems will not work unless the bather is in the oxypool and the action of the water can alter your sense of touch and balance as your foot "seeks" the bottom of the tub.

TURNING ON THE OXYPOOL

Turn on the pump by pressing or touching your controls as described previously in the section on Operating the controls.

BATH ADDITIVES

A drop or two of a biodegradable liquid soap will cover you and the tub with bubbles. Most people enjoy having a few bubbles floating around them. Artize does not recommend using use oil based products because the oil will settle in the oxypool system. The oil can also create an environment conducive to bacterial growth. However, if you choose to use oil based additives, you must clean the system as outlined below immediately after use. Bath soaps have a variety of products usable in your whirlpool bath, that do not contain oil. They have many fragrances that can enhance your whirlpool pleasure.

Be sure that any items you select for your bathing pleasure do not contain OIL ADDITIVES!

Enjoy your oxypool... There is no finer whirlpool made than an Artize oxypool...

USER MAINTENANCE INSTRUCTIONS

Cleaning The Tub Surface

- For daily maintenance cleaning, use a moist cloth and gentle liquid detergent
- For acrylic surfaces, occasional use of a special acrylic surface cleaner will add lustre and protect the finish
- Proper care and maintenance will preserve the high gloss acrylic finish
- To properly clean the surface, wipe with a soft damp cloth, or sponge, using household soap or liquid detergent
- DO NOT USE abrasive cleaners, scrapers, metal brushes, or any items or products that could scratch or dull the surface. HARSH CHEMICALS SHOULD NOT BE USED ON SURFACE
- The jets can be removed for cleaning. Use wrench provided with the tub. Do not remove the protective cover on the suction return for cleaning The only time the protective cover is removed is to replace the decorative ring
- Alcohol may be used to remove glue, adhesives, etc. from the surface

Cleaning The Pump And Plumbing System

After the tub is installed and ready to use, remove all construction debris and clean the tub and pump system. Clean the pump and plumbing system before first use and every month thereafter, regardless of utilisation. This is easily done as follows:

1. Set air control knobs to the closed position (turn counter clockwise).
2. Using hot water only, fill the tub to at least 2 inches above the highest jet.
3. Add 2 tablespoons of low sudsing automatic dishwasher detergent. Every other month use 1/2 cup of household bleach for cleaning the system, along with the detergent powder.
4. Operate the whirlpool for 20 minutes.
5. When the pump system stops (except on Air Switch units which have to be turned off manually), drain the water from the tub.



CAUTIONS

Opening the drain without tools may damage the surface and the pump. Call Jaquar's service team to service the product.

- Extreme heat from portable heaters and cigarettes can damage the surface of the tub.
- We do not recommend the use of oil based bath additives. Salts or other mineral salts may be used in the tub.

Minor Scratches And Scuffs

The procedure to remove light surface scratch or burnish marks is quite simple. Apply automobile rubbing compound and lightly buff, then apply paste wax and lightly buff again. This will return the original shine.

Major Repairs To The Surface

Should a deep scratch or more serious damage occur, please call your installation professional.

Jet Hardware Wrench

The wrench that is included with your tub is used to remove hardware for cleaning, replacing or adjusting the nozzle. Refer to the diagrams below for how to use this wrench. Again, use no abrasive cleaners. Use mild detergent and a soft cloth or sponge when cleaning. Do not remove the cover on the suction return. This cover is removed only when replacing the decorative ring.



Depending on the frequency of use check and clean the sieve of the milk system approx. every 1-2 months.



Unscrew the cover.



Use the comb pliers to pull out the sieve on the plastic pin.



Clean the sieve, check for damage and reinstall in reverse order. Replace damaged sieve.

TROUBLESHOOTING

Oxypool System

Pump is not functioning smoothly

- Adjust jet nozzle direction
- Unscrew the filter from the suction fitting and clean. Never obstruct the suction filter
- Make sure that pipe connections to the motor are tightened enough (tighten by hand)
- It is highly inadvisable to wash your hair while the whirlpool pump is operating. Loose hair could eventually plug or damage the pump

Jet is not functioning

- Open both air controls and try again. If jet still does not work, verify that jet hole is clear of all debris. If problem persists, contact Technical Service

Jet is leaking

- Put a silicone seal around the jet body on the outside of the bathtub. If jet still leaks, contact Technical Service

Suction fitting is leaking

- Put a silicone seal around suction body on the outside of the bathtub. If suction still leaks, contact Technical Service.

Water pump does not turn on

- Some bathtubs are fitted with a low water detector that prevents the motor from starting if the water level is insufficient. Fill tub with water and try again
- Make sure that the electric connection between the pump, electronic box and the electronic control panel is well established and that all fuses are functional. Reconnect if necessary
- Verify that electricity is supplied to pump via electronic unit and circuit breaker/safety device (i.e. RCCB/GFCI Breaker)

Save this manual for future reference

NOTICE FOR INSTALLER:

Owner's Manual shall be left with the home owner or with the tub after installation. Important safety instructions, warranty information and the product registration card are contained within.

TAPE THIS PACKET TO THE TUB OR LEAVE IN AN OBVIOUS PLACE

For any installation and maintenace related enquiry
please call Customer Care at 1800 121 6808 (Toll Free)
or email us at info@artize.com

